

- O( %
- \$ , °:
- ' \$' M
- J < CM
- @ - .
- ) )' M&ac ( ' %
- @k



<L: \$ . , J' . ' ; MŽJMŽ . , N

O' \$\* ' , M&ac

	(1)		(2)			
				120Vac	220Vac	

( ' ' \$ ) + ' M&ac  
 ) )' M&ac ( ' %  
 J < CM

				@: - ' , O/ \$( 2 ) + ' M&ac & - ' ? z
				( ' ' % ( ' ' M&ac
				( ' ' % ) )' M&ac
@k				) )' M&ac ) , ° ( ' % @k \$( ' % @k = O- ' l j

				( ' ' \$) . . Mac#, ' \$' ? z#- , %\$( ' ' %
				Ž+O\$, N ž

				( ' ' %
				( ' ' %
				( ' ' %
			±	( ' ' %
			±	
				( ) ' Mac & ) ' Mac#- , %\$( ' ' %
				( ) ' Mac & ) ' Mac#- , %\$( ' ' %
				\$*, °: - \$( ' °:
				( ) ' Mac & ) ' Mac#- , %\$( ' ' %
				\$, °: - \$*, °:
			°	= ' ° - Kc
( ) M				
( ) M				" ; im - "

), °:

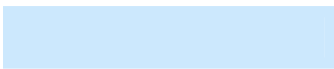

	o		o	
	o		o	,
	o		o	1, % I ? kf ( ' ' % I ?
$\check{C} \times N \times ? \check{z}$ $\check{C} \times N \times ? \check{z}$	$- \% ) \times ) \% - \times ( \% +$ $( , / \times - . \% \times * - \%$			$. \% 0 \times ) \% - \times ( \% +$ $( / , \times - . \% \times * - \%$

), °:

' ~ ( ' M				
' ~ ( ' M	μ	μ	μ	

), °:

<b>EMI</b>	
<b>EMS</b>	

EMS	

ž ž <D @

ž ž <D @

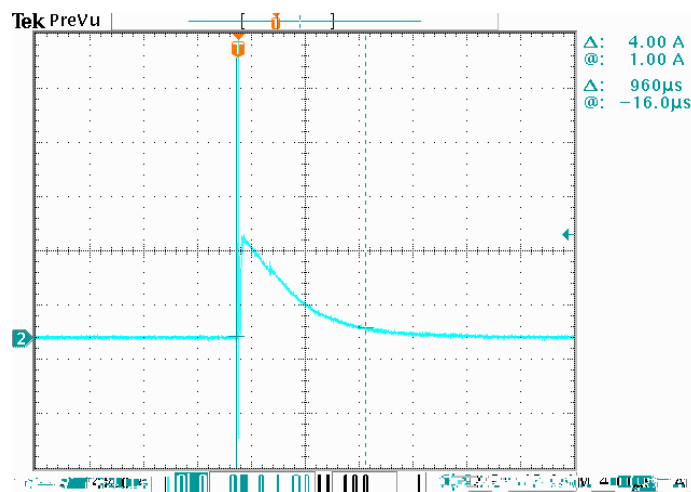
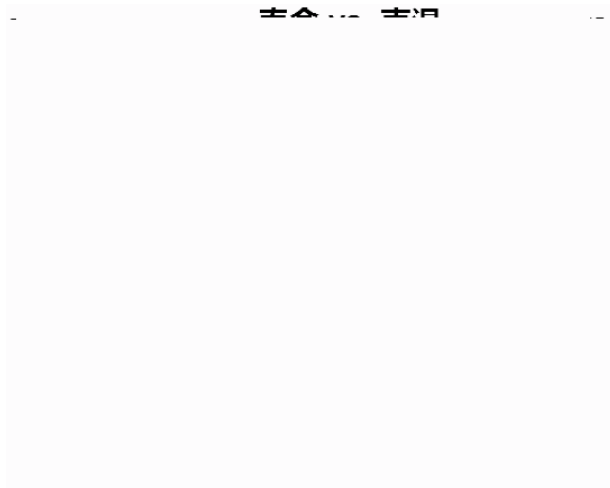

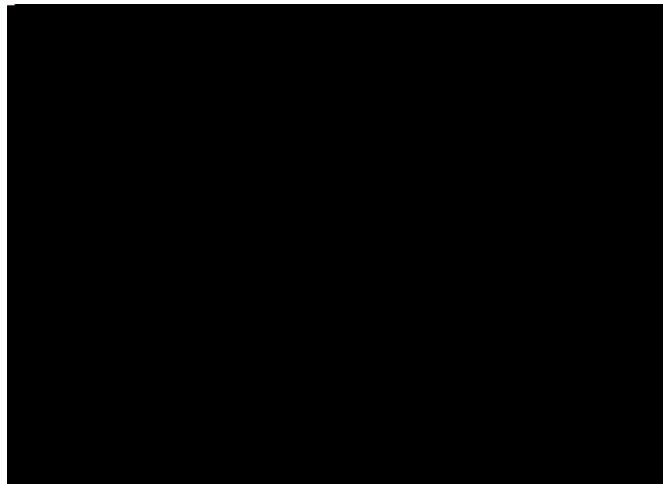
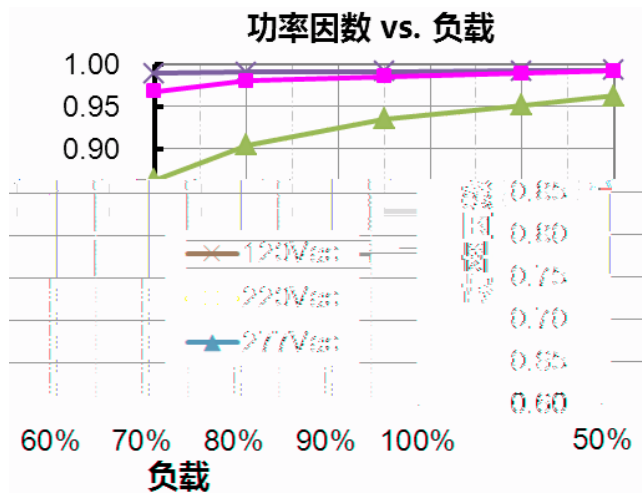
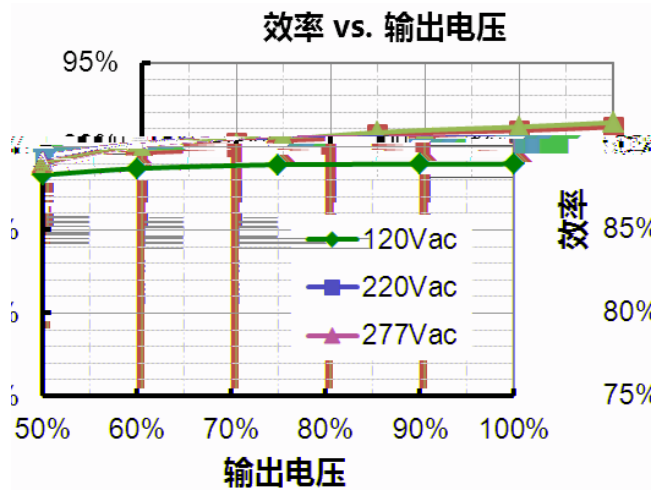

( )' Mac )' Mac

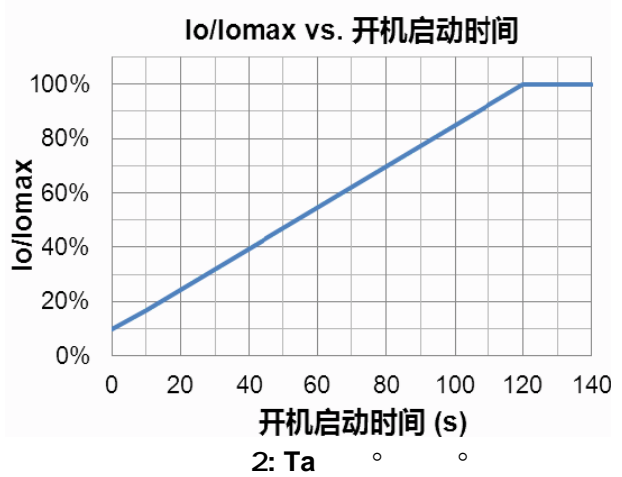
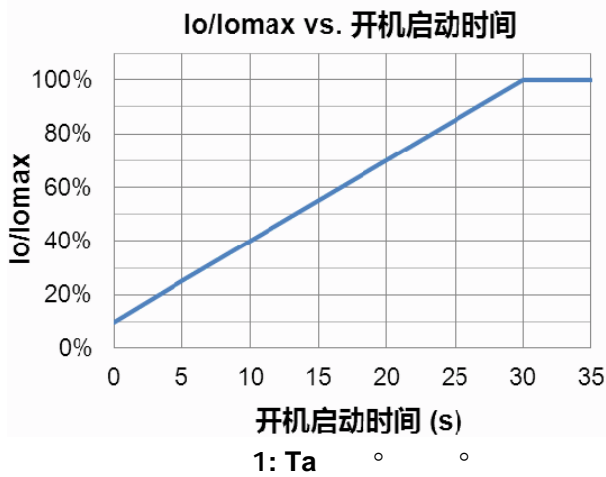

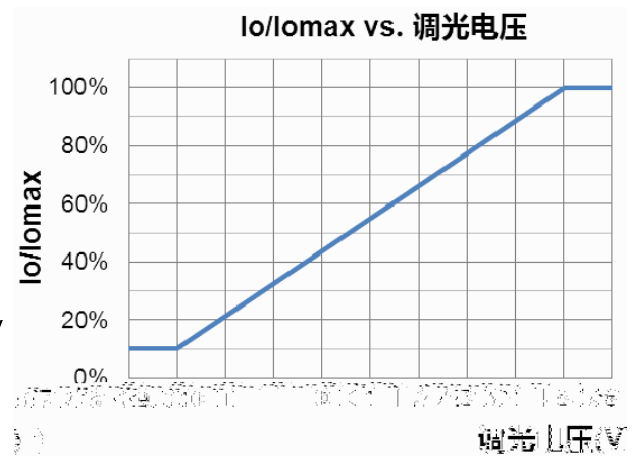
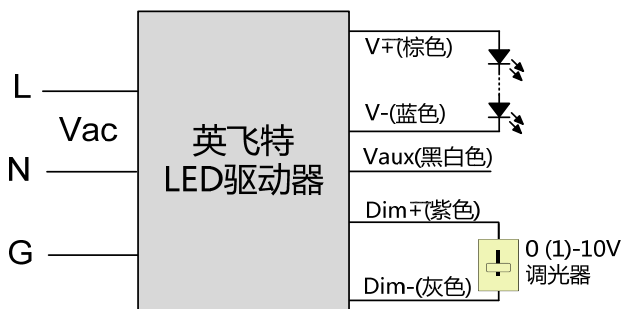

0-10V

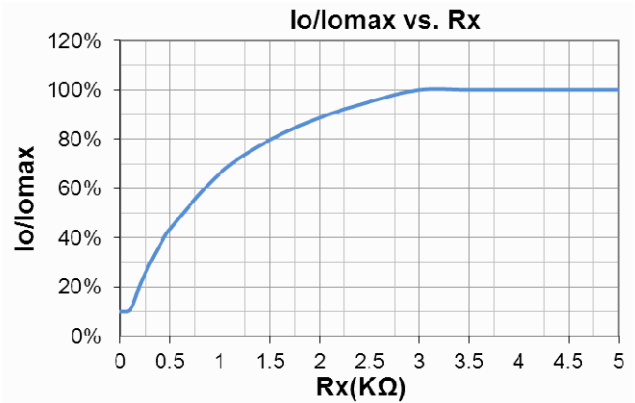
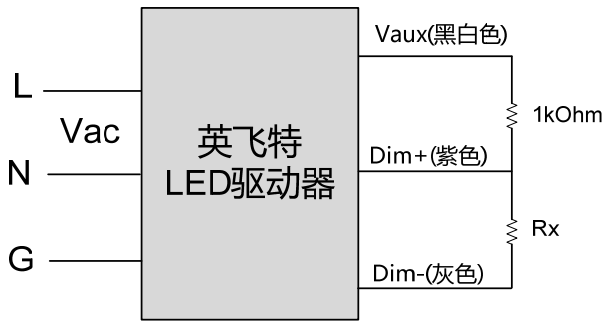

1 DC

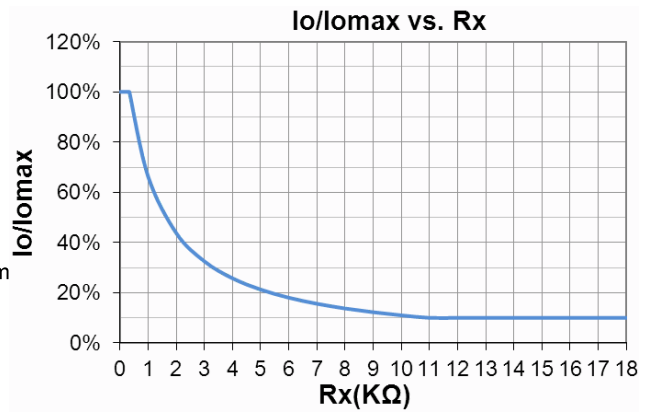
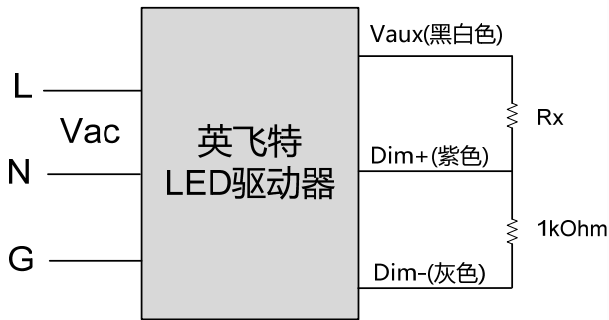

2



3

(%        ' \$( ' M  
 )%        ; im\$        M\$    M  
 \*%        ; im"        M&l x

## EUC-075S070DVY

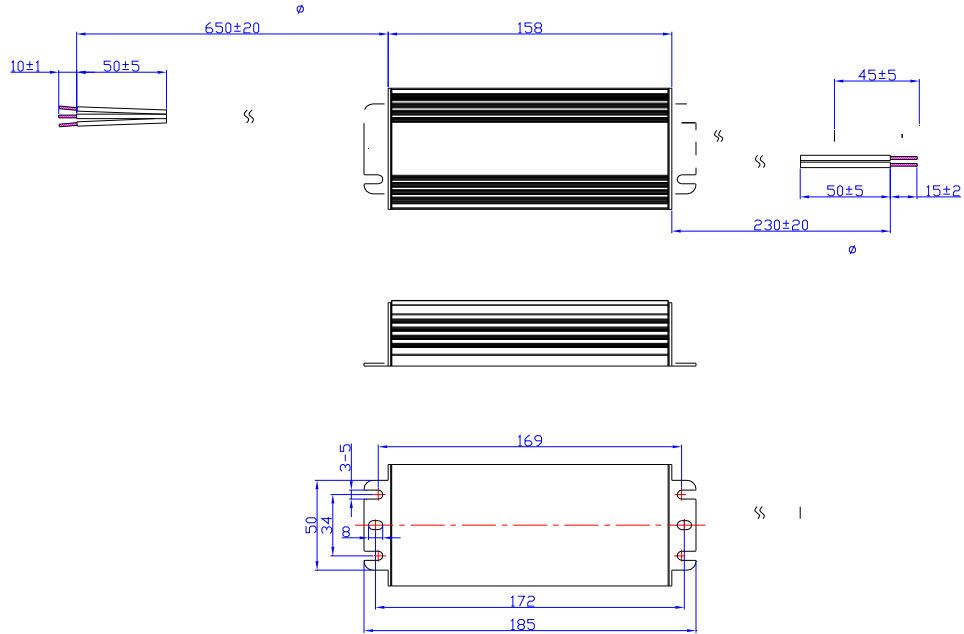

		&
		&
		&
		,
	&	, ' \$ ' ? z
		&
		' ~ ( ' M
		&
		&
		&